

Accessory	Application	Publications No.
SNOWBOARD ATTACHMENT 08L03-E09-100B	2015 ODYSSEY	VERSION 1
		Issue Date JULY 2014

PARTS LIST

2 Snowboard Carriers

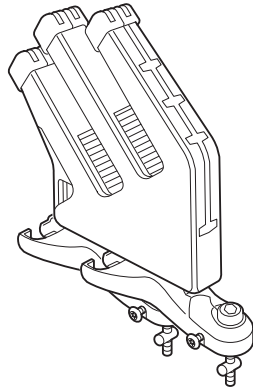

4 Bottom clamps

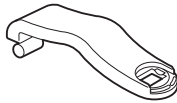

16 Rubber blocks



4 Board Supports



2 Keys



TORX wrench

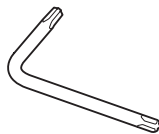

2 Locking cables

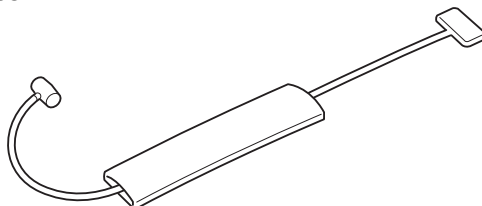

INSTALLATION

NOTE: Be careful not to damage the paint finish.

1. Rotate the two top clamps on the snowboard carrier so they are perpendicular to the carrier.

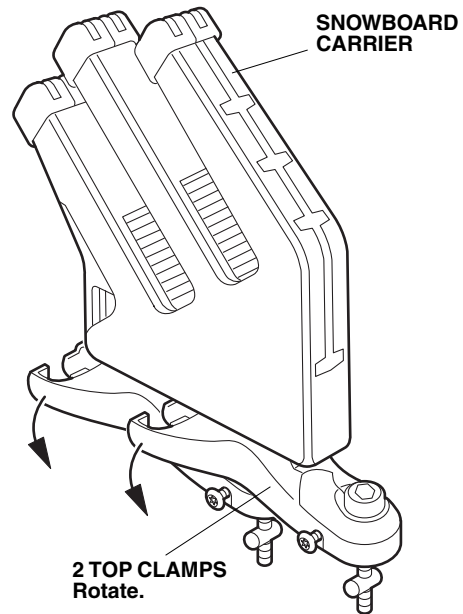

2. Install two board supports into the snowboard carrier.

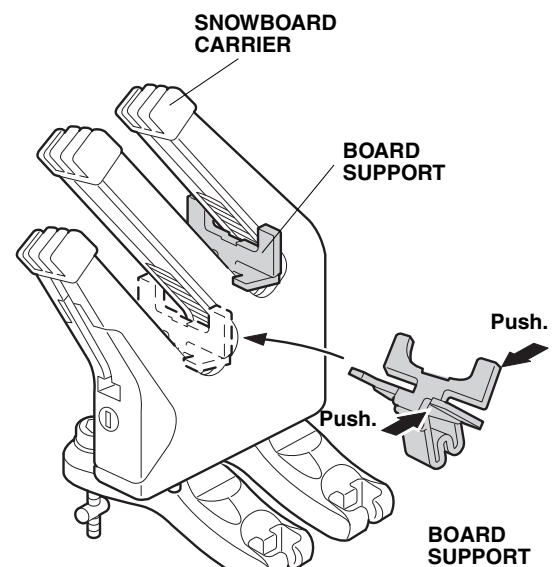

3. Install four rubber blocks on the top and bottom clamps. Install the rubber blocks with the top of each triangular mark (Δ) facing the inside.

Install the rubber blocks with the X marks facing the clamp.

TOP CLAMP

RUBBER BLOCK

(Δ) MARK
Install the rubber blocks with the top of this mark facing the inside.

RUBBER BLOCK

(Δ) MARK
Install the rubber blocks with the top of this mark facing the inside.

RUBBER BLOCK

RUBBER BLOCK

Install the rubber blocks with the X marks facing the clamp.

4. Turn the two cam levers on the top clamp counterclockwise.

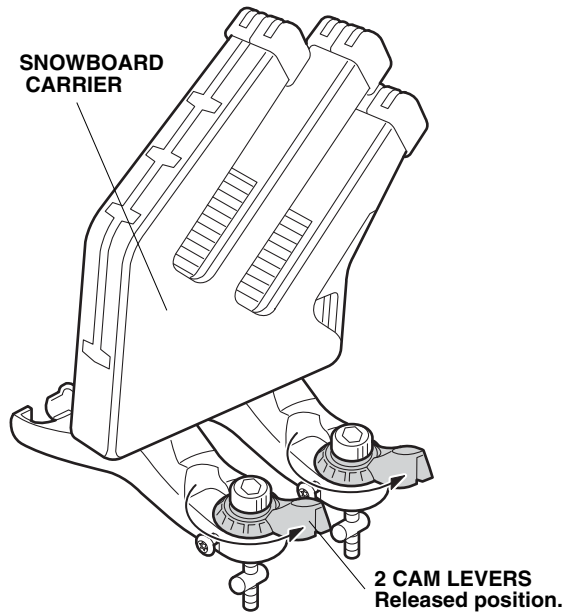

5. Attach the two bottom clamps to the top clamps.

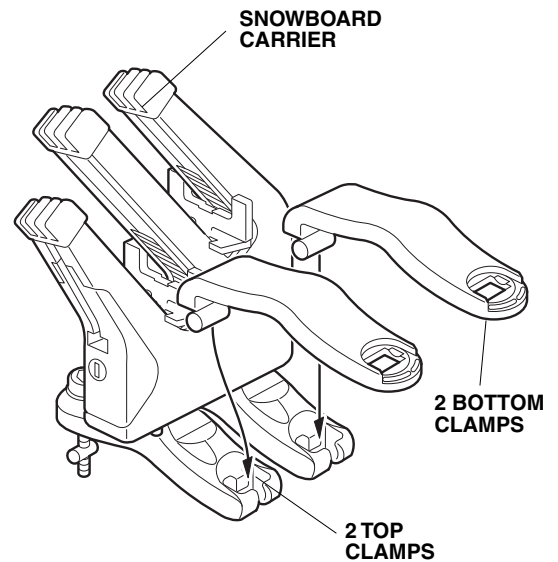

6. Repeat steps 1 thru 5 to assemble the other carrier.

- Attach one carrier to the front crossbar in the direction shown. Insert the barrel nuts on the top clamps into the square holes in the bottom clamps, then turn the four barrel nuts 90° to lock them in position. Install the other carrier onto the rear crossbar.

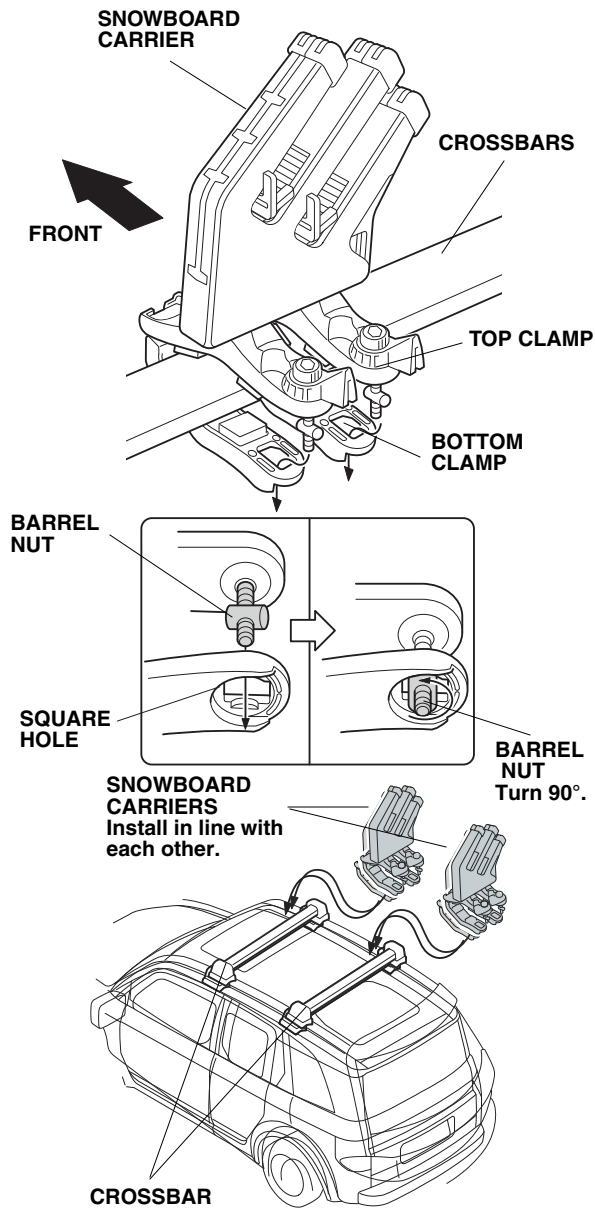

- Turn the knobs on the top clamps to tighten the snowboard carrier.

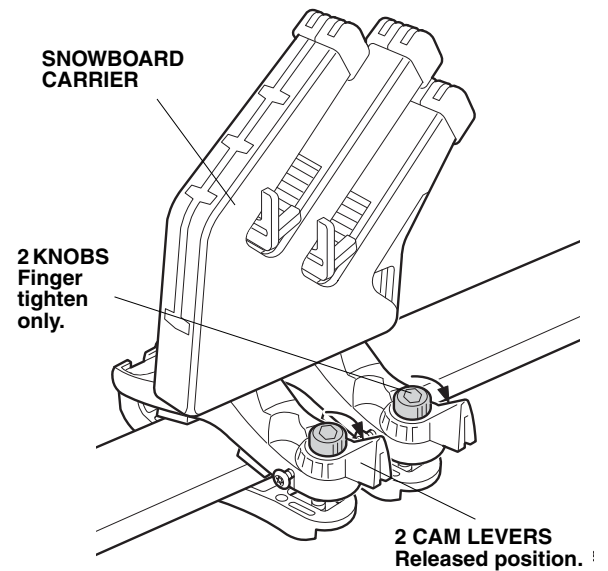

- Return the cam levers to the original position (turn clockwise).

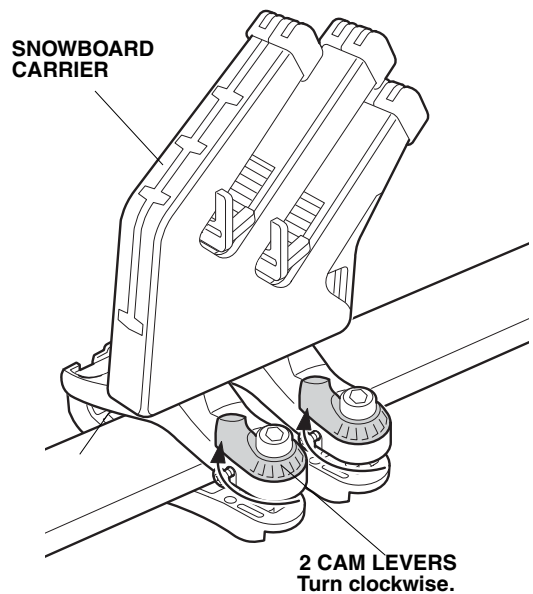

10. To prevent theft, install the screws in the holes in the top clamps.

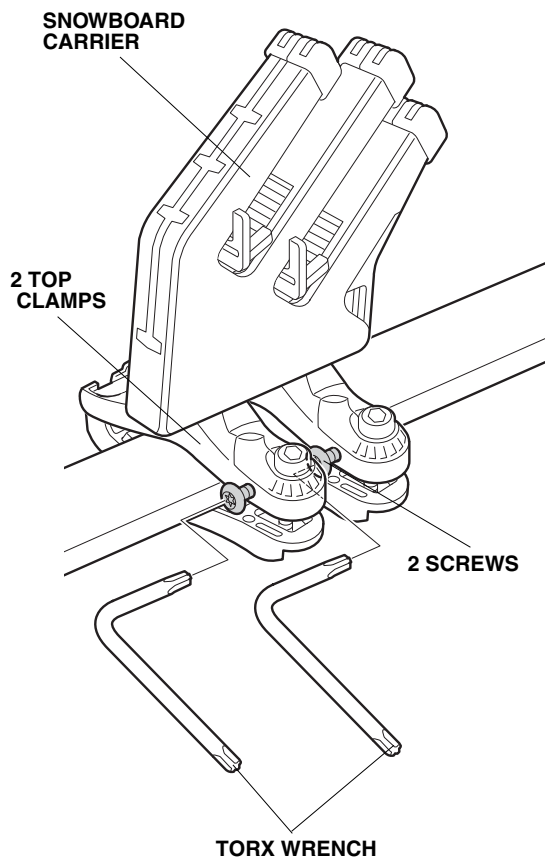

11. Repeat steps 8 thru 10 to secure the other carrier.
12. Try to rock the carriers to make sure they are securely installed.

13. Insert the locking cable plate into the slot in each snowboard carrier. To carry one snowboard, insert the plate into the lowest slot. To carry two snowboards, use one of the three upper slots in the carrier.

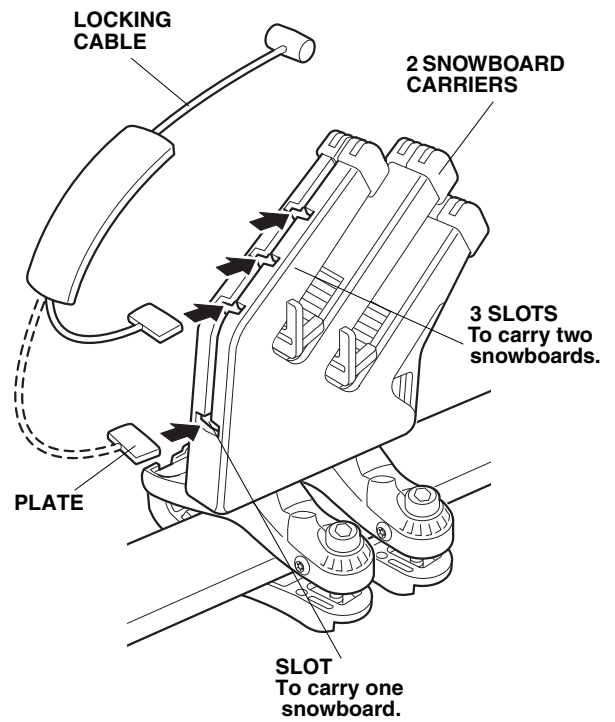

14. After loading the snowboards on the carrier, adjust them with the help of the board supports so that the top edges are level and the boards are as far down in the carrier as possible. To secure the snowboards, use the key to open the covers, then insert the locking cable barrels into the holes in the carrier covers.

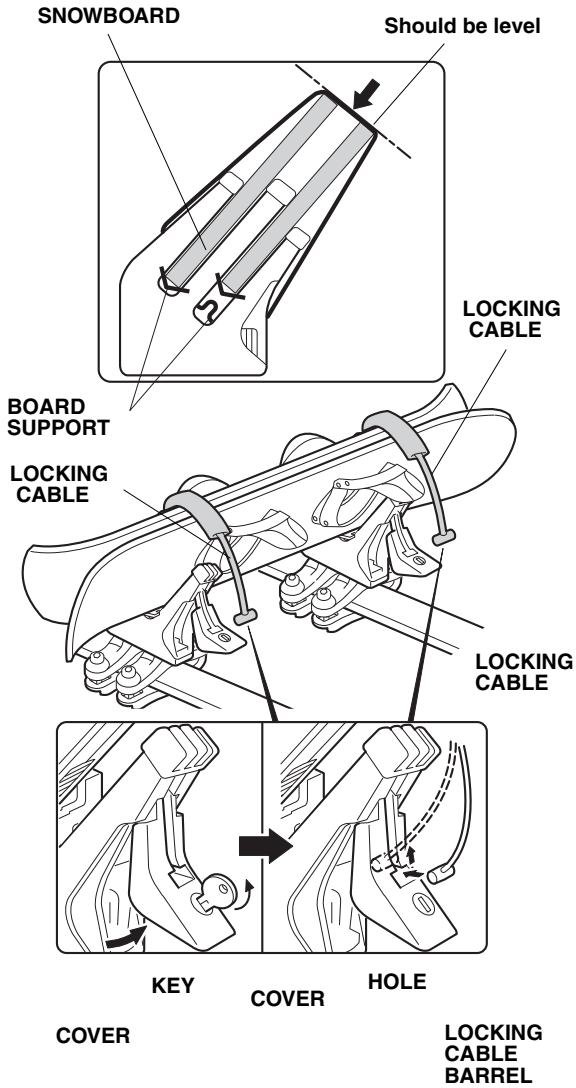

15. Check that the locking cables are installed securely, then close the covers.

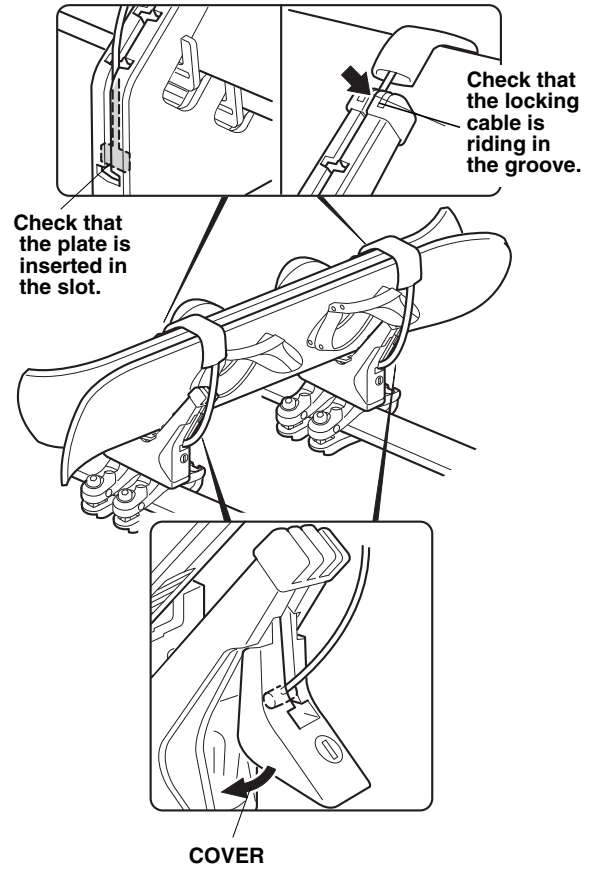

16. Lock the covers with the key before driving.

